

# BYO

BUILD YOUR OWN

## MODULAR DWELLING 100

Designed by Edgar Blazona

### 10' X 10' MODULAR DWELLING

 **\$1,500**   

#### INGREDIENTS:

- 3" square-drive deck screws
- 1 1/2" Phillips self-countersinking wood screws (exterior grade)
- Sheet-metal screws for wood with rubber washers
- 5 tubes of clear silicone caulking
- 1 gallon Man O' War exterior marine varnish
- 1 quart Rust-Oleum aluminum paint
- Mixing bucket for paint
- Paint sticks for mixing
- 2 rolls of roofing asphalt
- 5 pounds of 3/4" roofing nails
- 2 tubes of Henry's Asphalt Roof Coating
- 5 10' lengths of 1" x 1" drip-edge metal flashing
- 6 8' lengths of 5/8" x 1" flashing
- Corrugated foam material
- 1/2" particleboard or Sheetrock (optional)
- Wall insulation (optional)
- 1 36" x 80" door (we used birch)
- 2 satin nickel-plated door hinges
- Locking door knob
- 9 concrete piers

#### TOOLS:

- Circular (skill) saw
- Chop saw
- Table saw
- Electric drill
- Orbital sander with 120-grit sandpaper
- 4 sawhorses
- 16' tape measure
- Carpenter's square
- Carpenter's pencil
- Carpenter's knife
- Chisel
- Hammer
- Abrasive metal-cutting blade for circular saw
- Tin snips
- Caulk gun
- String line
- String line level
- Shims
- 5 sheets of 220-grit sandpaper
- 5 smooth-wall foam paint rollers
- Paint thinner
- Blue masking tape
- Cloth rags
- Safety goggles
- Earplugs
- Work gloves
- Clamps



All do-it-yourself activities involve risk. Skills, materials, tools, and site conditions vary widely. Although the editors have made every effort to ensure accuracy, you remain responsible for the selection and use of tools and methods. Obey local codes and laws, follow manufacturers' operating instructions, and observe safety precautions. Be careful out there.

# ReadyMade

# FRAMING

The first step in building your MD100 is to assemble the four walls, the floor, and the roof frame.

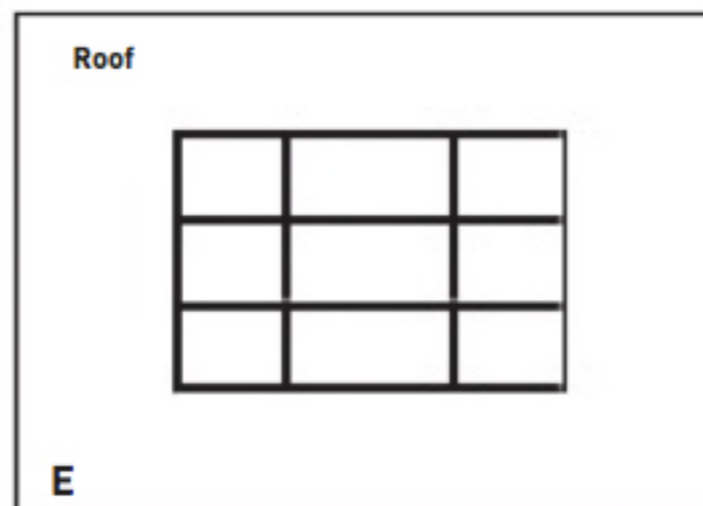
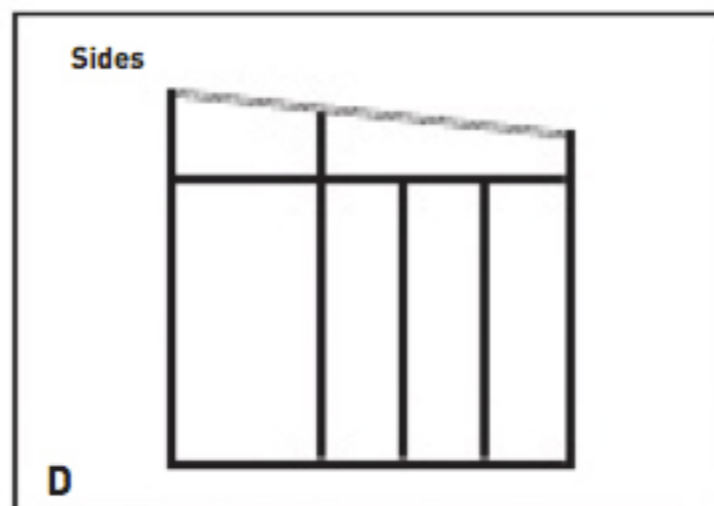
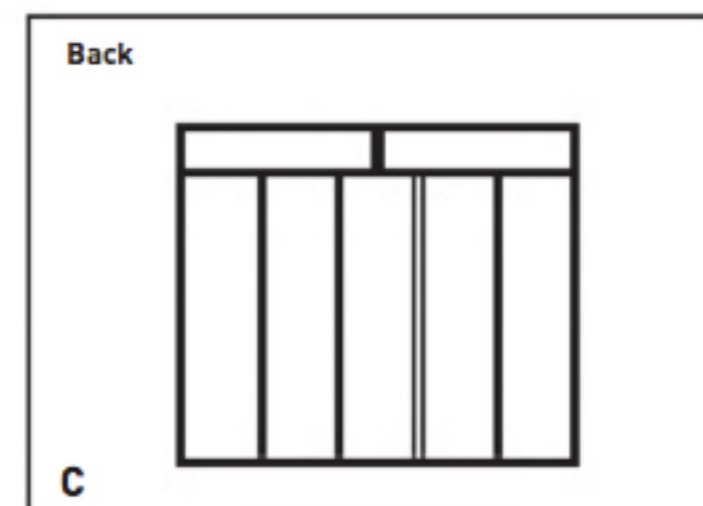
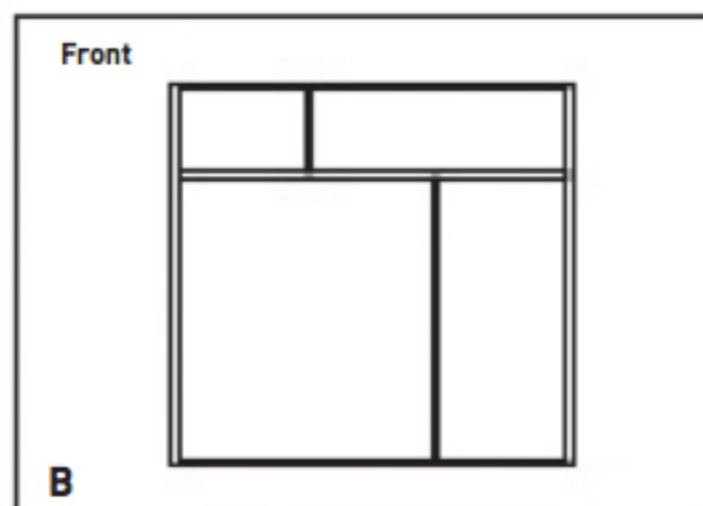
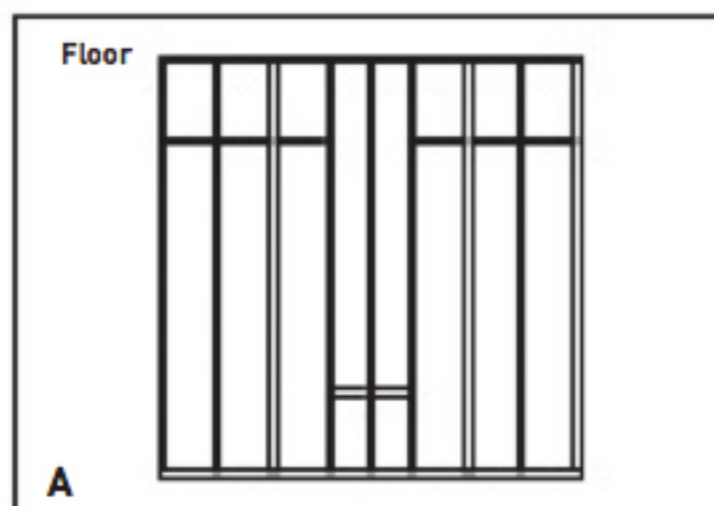

## Floor frame (all wood is 2" x 4")

- 2 120" lengths
- 9 117" lengths
- 2 10 1/2" lengths
- 6 14 1/4" lengths

**Tip:** If you're cutting the wood yourself, use a chop saw for all the pieces except the 10 1/2" lengths. Note that only two of the nine 117" lengths will be exposed when the building is done, making this a good place to use the wood that has dings or is not quite as pretty as the rest.

**Diagram A:**  
 Set out four sawhorses in a 10' square on a level surface. Use the 3" square-drive deck screws to assemble the two 120" pieces with two 117" pieces to make a 10' square. Use screws on exposed areas to help prevent rusting. Assemble the rest of the floor joist using the deck screws. Screw in the outside pieces of 14 1/4" blocking from the outside in. This blocking will be used to screw down the

**Tip:** You can use the 14 1/4" pieces to achieve the correct spacing in the floor joist. Work from the outside in, leaving two 10 1/2" spaces in the center.

plywood floor later. Check the remaining blocking dimensions for exact size (about 10 1/2", depending on wood thickness). Cut the blocking to the correct size and install. The plywood floor panels will be laid down when the building is erected.

## Front frame (all wood is 2" x 4")

- 2 108" lengths
- 3 110" lengths
- 1 80 3/8" length
- 1 23 1/8" length

**Tip:** Use the straightest and least-damaged wood for the front wall. Make sure all lumber markings are hidden from view.

**Diagram B:**  
 Use the deck screws to assemble the outside rectangle with two 110" and the two 108" pieces. Assemble the inside portion starting with the remaining 110" horizontal piece.

(Use the 80 3/8" piece as a guide to determine where to screw in the 110" horizontal piece.) Now screw in the 80 3/8" piece in the correct location to create the entryway, which *must* be perfectly square to install the door. Screw in the remaining 23 1/8" piece. Note that this opening is the same width as the door opening.

## Back frame (all wood is 2" x 4")

- 2 96" lengths
- 3 110" lengths
- 4 80 3/8" lengths
- 2 11 1/8" lengths

**Diagram C:**  
 Assemble the outside rectangle using two 110" and 96" pieces. Lumber markings should face in. Screw in the remaining 110" horizontal piece using an 80 3/8" piece as your guide. Now screw in the 80 3/8" pieces. Cut two

scrap pieces of wood at 20 7/8" to use as a guide between the studs. Working from the outside in, alternate from side to side. The center dimension will be slightly different. Screw in the two 11 1/8" pieces at the center of the opening.

## Side frames (all wood is 2" x 4")

- 2 113 3/8" lengths
- 2 96" lengths
- 2 108" lengths
- 4 113" lengths
- 6 80 3/8" lengths
- 2 18 3/4" lengths

**Diagram D:**  
 The directions for assembling the right and left sides are the same. If you're cutting your own wood, cut all pieces except the 113 3/8" for both right and left sides. Screw the 96" and the 108" pieces to the 113" piece to make a "U" shape. Attach the remaining 113 3/8" horizontal piece using the 80 3/8" lengths as guides to determine the exact positioning. Screw in the 80 3/8" pieces starting at the back (Fig. 1). Cut two scrap pieces

of wood at 22 1/2" to use as guides between the studs. Measure and cut the angled horizontal piece (113 3/8"). Now screw it in. Cut the 18 3/4" piece with one 84° angle cut. Fit into place and screw together from the top on the side that will not have Plexiglas installed so the screws won't show through.

## Roof frame (if using 1/2" wall paneling or Sheetrock, use these dimensions)

- 2 73 1/2" lengths
- 4 112" lengths (if not covering walls with sheetrock or paneling, use 4 113" lengths instead)
- 6 22 1/2" lengths

**Diagram E:**  
 Screw the two 73 1/2" pieces to the outside 112" horizontal pieces to create a rectangle. Screw in the two remaining 112" pieces using the 22 1/2" pieces as spacers, then screw in the 6 22 1/2" pieces.



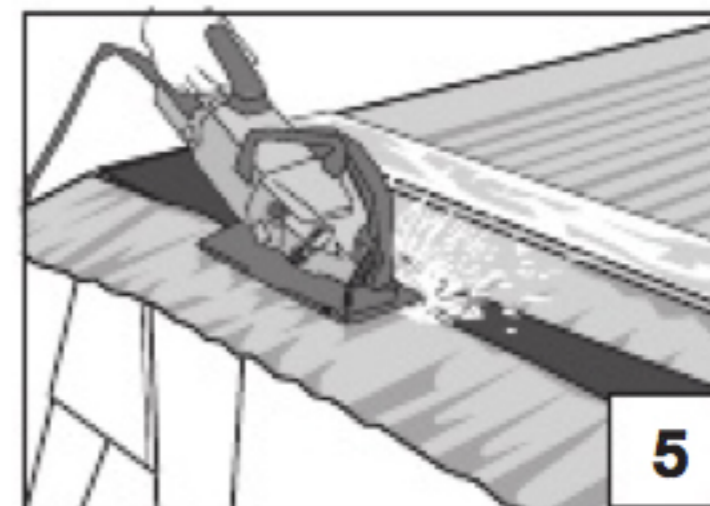
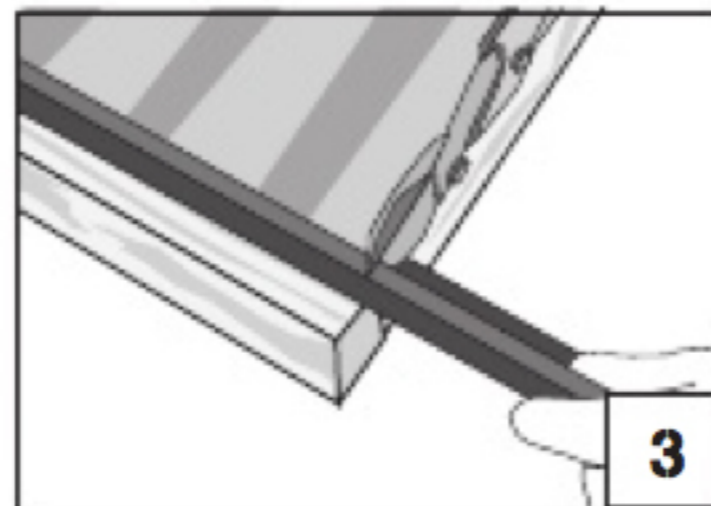

## METAL SIDING

It's best to assemble this on sawhorses for easy access to both sides of the wall.

- 8 6' pieces
- 4 111" pieces (cut to size)

### Side walls

Start from the bottom and center the 72" metal siding between the two horizontal 2" x 4"s (Fig. 2). Place the siding flush to the outside edge of the 2" x 4"s. Lay out the four

sheets so they fit evenly between the 2" x 4"s. Overlap the siding, tucking each lower sheet under the upper sheet, to prevent water from seeping in. Fit the "J" flashing along the edge of the corrugated metal. Mark and cut to size (about 82½") with tin snips (Fig. 3). Fit the flashing into place. From the bottom, carefully push in the corrugated foam material

(Fig. 4). Screw in the bottom portion of the corrugated metal using the sheet-metal screws. Screw right through the metal siding and into the 2" x 4". Working from the bottom up, screw in the corrugated panels. [Screws should be 19" to 20" apart.] Screw down the side and flashing, slightly angling the drill to tuck the screw under the flashing.

### Back wall

Starting from the bottom, lay out the 120" corrugated metal. One edge of the metal should be ½" from the outside edge. The corrugated metal will overhang the other side. Screw in the side that doesn't need trimming, following the instructions for the side walls. Trim the metal to 111". Use a straight 2" x 4"

to mark a line on the steel. To prevent the steel from getting scratched, cover the good side of the line with masking tape, including where the skill saw will rest (Fig. 5). Set the depth of the blade to cut only the metal, but don't worry if it roughs up the 2" x 4" slightly. Trim the metal. Assemble the "J" flashing and corrugated foam, and screw into place.

## EXTERIOR PLYWOOD PANELS (all ¾" thick)

**Tip:** To ensure a perfectly straight cut, use a long piece of wood as a guide for the saw. Mark a line where you want to cut. Measure the distance from the edge of the blade to the edge of the bottom plate on the saw. Clamp the long, straight piece of wood to the piece to be cut. Make sure the straight wood is the same distance from the cut line as the edge of the blade to the bottom plate of the saw. To cut, run the saw along the clamped piece of wood (Fig. 6). After all the pieces are cut, use the orbital sander and 120-grit sandpaper to smooth the surface and edges. Bevel the top edge to help prevent splintering



### Floor

- 2 4' x 8' pieces
- 2 2' x 4' pieces
- 1 2' x 8' piece
- 1 2' x 2' piece

### Roof

- 3 48" x 81½"
- 3 48" x 63"

### Sides

- 1 42" x 82½"
- 1 42" x 20" x 42" x 2¼"
- (trapezoid) 
- 2 72½" x 20" x 72½" x 12½"
- (trapezoid) 

### Back

- 2 12½" x 55½"

**Silver-staining the plywood and door.** Use a paint stick to mix the Rust-Oleum. In a bucket, thin half of the Rust-Oleum with an equal part of paint thinner. Use a foam roller to apply the mixture evenly to the plywood, including edges (Fig. 7). (Don't apply the paint in direct sunlight as it will dry up fast!). Let the stain saturate the wood for 5 minutes. Use a clean, dry rag to remove excess

paint, wiping in the direction of the grain to avoid a streaky look. Repeat these steps for both sides and edges of the door. Let pieces dry overnight.

**Applying clear finish to plywood and door.** Apply three even coats of Man O' War (real name!) finish to all exposed surfaces of the plywood, including the door. Allow each coat

to dry overnight. After each coat has hardened completely, lightly sand by hand with 220-grit sandpaper (taking care not to sand through your sleek new coat).

**Installing plywood siding.** After all three coats of the Man O' War finish have been applied, place one wall frame face-up on the sawhorses. Set the plywood into place and

align all pieces. If everything fits together correctly, remove the panels and set aside. Lay down a ¼" bead of clear silicone caulking where the plywood will be installed. Carefully set the plywood in place and screw it to the frame every 12" to 20". Wipe off excess silicone globs with a damp rag. Continue until all of the plywood siding has been installed.

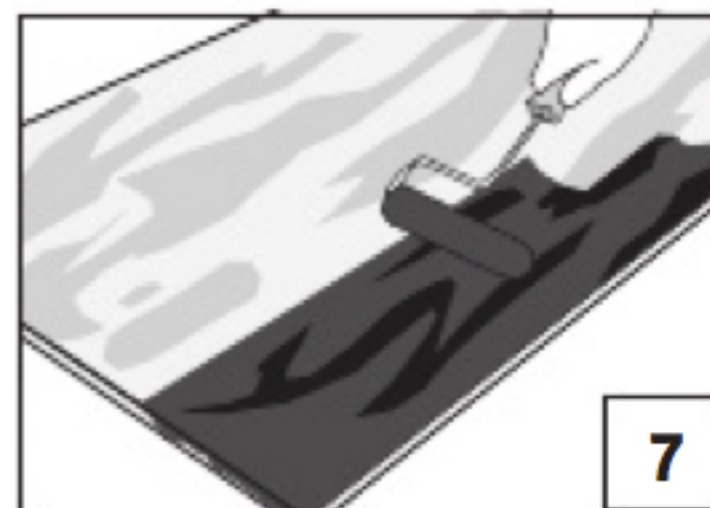
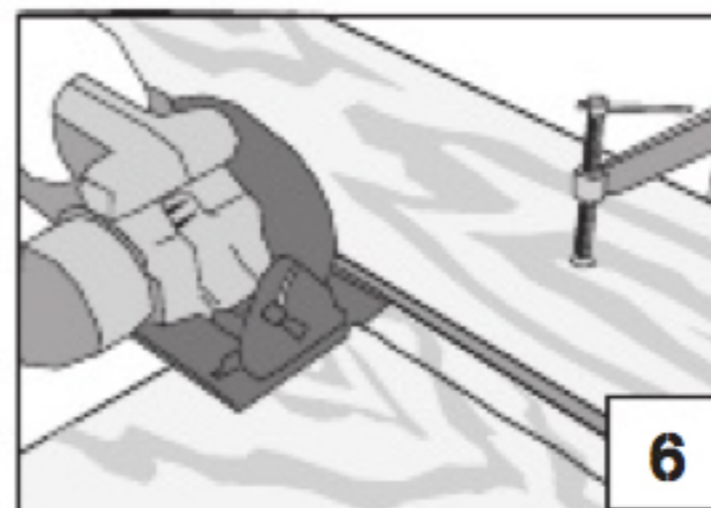

# WINDOW FRAMING AND CONCRETE FOUNDATION

## Plexiglas (all 1/4" thick)

- 1 40 1/2" x 80" (side)
- 2 35 3/8" x 80" (front)
- 1 22 3/4" x 36" (top front)
- 1 71 1/4" x 22 3/4" (top front)
- 1 40 1/2" x 18 1/2" x 40 1/2" x 22 1/2" (trapezoid) □

## Wood stops for windows and door (all 1" x 2")

### Window stops:

- 8 80 1/2"
- 4 34 3/4"
- 6 39 3/8"
- 4 70 3/8"
- 2 18 3/4"
- 2 22 3/4"
- 2 39 1/2"

### Door stops:

- 2 80 1/4"
- 1 34 1/2"

**Tip:** Using tempered glass instead of Plexiglas is an elegant and scuff-resistant alternative. But be warned: it'll cost you.

Cut all the Plexiglas stops to the correct size. (Set the chop saw to 84° for the triangle-shape glass stops). Place the front wall facedown on the sawhorses. Installing one piece at a time, apply a 1/4" bead of clear silicone to the Plexiglas stop. Screw in the wood stops 1/8" down from the edge of the 2" x 4"s. [At this point you will be installing only one side of the Plexiglas stops.] Wipe away excess silicone with a damp rag and remove the front wall from the sawhorses. Place the side that will have the trapezoidal piece of Plexiglas on the sawhorses. Install stops as above.\*

**Concrete piers:** Place the nine piers on level ground. [To level the ground, build up dirt below the piers, compacting it as much as possible.] Use a level and a string line between the piers to make sure they're on the same plane. If not, the building will be out of square, making it very tricky to install the door and windows.

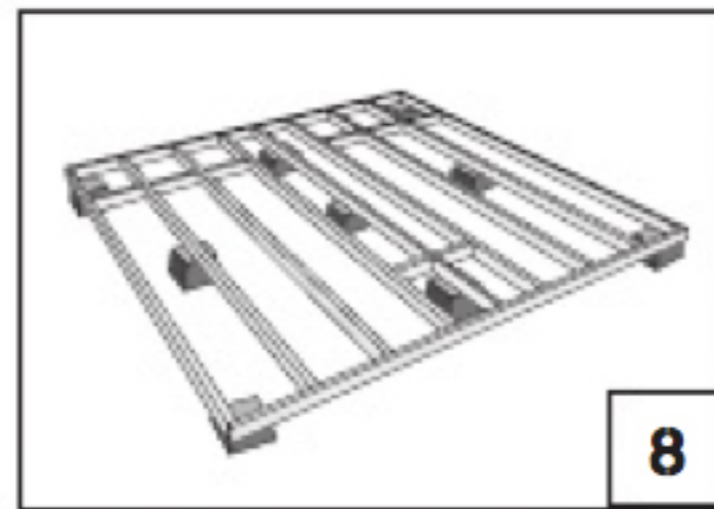

\*Installing wood stops for the Plexiglas

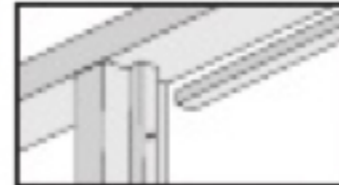

## ASSEMBLING THE STRUCTURE AND ROOFING

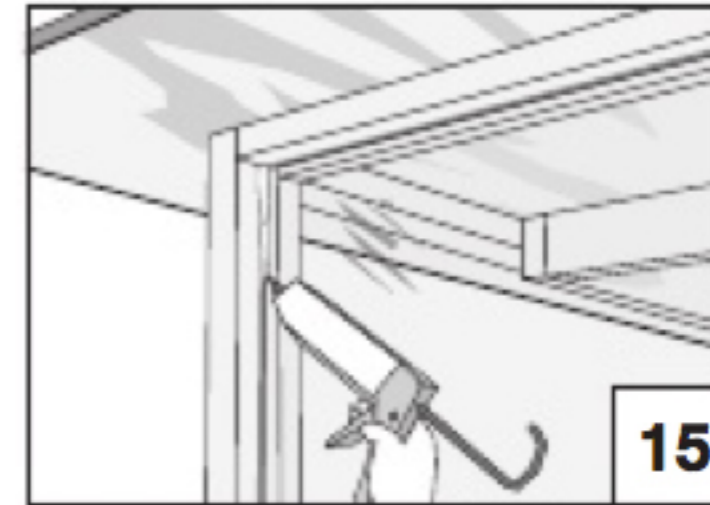
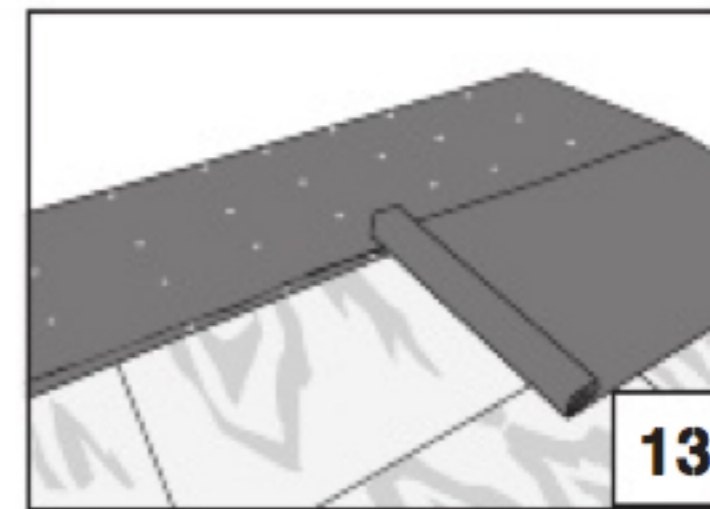
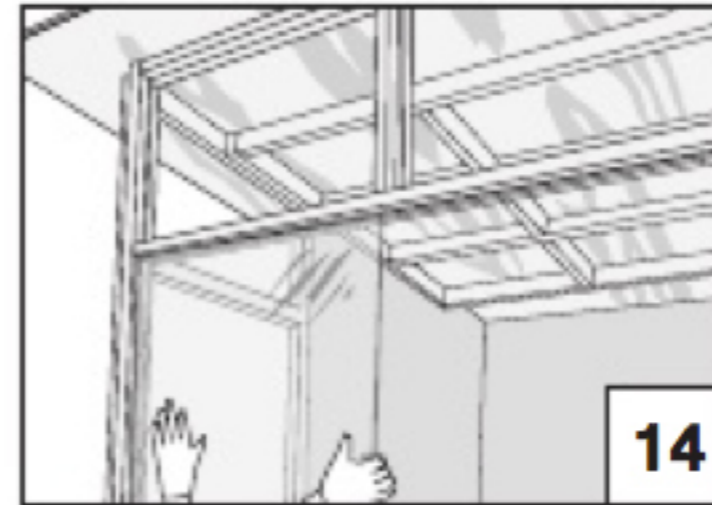
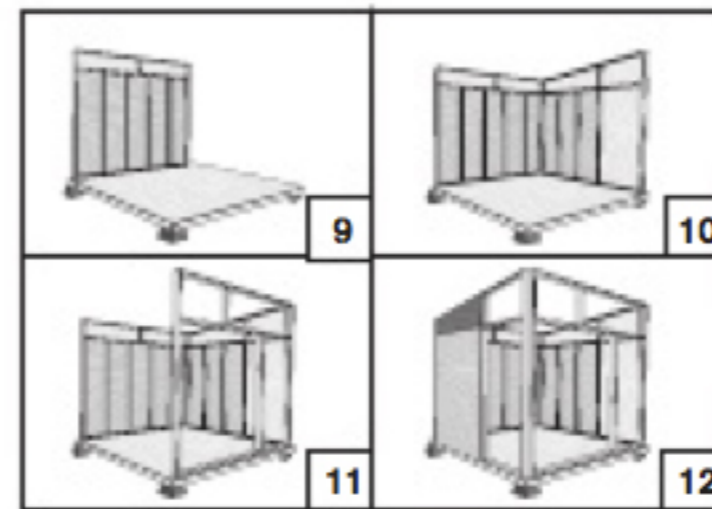

**Floor.** Place the floor frame on the level piers (Fig. 8). If the piers have settled beyond level, use shims to set it straight. Place the plywood floor pieces on the frame, staggering the panels. Screw down the plywood to the frame using the self-countersinking wood screws.

**Walls.** Lift the back wall into place and make sure it's against the back edge of the plywood (Fig. 9). Slide the wall to the right until it is 3 1/2" from the right edge. Secure the wall to the floor using two screws every 12" to 16". Have friends hold up the back wall while others carry in the right wall and lift it into place, sliding it back until the vertical 2" x 4"s of each wall overlap (Fig. 10). Screw the two walls together using the 3" deck screws. Screw the wall to the floor as above. Lift the front wall into place. Slide it to the right wall, making sure the walls overlap. Screw the two walls together (Fig. 11). Now screw the wall to the floor. Erect the remaining left wall (Fig. 12). Screw the back wall and the front wall to the left wall. Screw the left wall to the floor.

**Interior paneling.** Want to cover up the framed walls with paneling or Sheetrock? Now's the time. We added insulation and used 1/2" particleboard to cover the interior walls.

**Roof.** Lift the roof frame into place. Line up

the front 2" x 4" of the roof frame with the vertical 2" x 4" of the right and left walls. Screw the roof frame to the right and left walls using the 3" deck screws every 6". Now lift the plywood into place. Use the 1 1/2" self-countersinking screws to attach the plywood to the roof frame and the walls. Climb up and roll out the first sheet of roofing from the bottom up to prevent water from seeping underneath. Using a carpenter's knife, trim the edges of the asphalt flush to the edge. Nail the asphalt edges every 12" and the field every 18". Apply the tar caulking across the edge. Roll out the second sheet of asphalt (Fig. 13). Nail it down around the edges. Continue rolling out sheets and nailing them down until the roof is covered. Starting in one corner, lay down a 1/4" bead of roofing tar along the edge of the asphalt. Nail down the drip edging with the 3/4" roofing nails. (It comes in 10' sections; use tin snips to cut four 30" pieces.) Nail down all remaining edging.

**Installing the Plexiglas.** Start with the largest front window. Lay down a 3/8" bead of silicone against the Plexiglas stops. Set the glass into place (Fig. 14). There should be no more than a 1/8" gap between the two front window sheets of glass. Once in place, lay down another 3/8" bead against the glass. Now lay down a 1/4" bead of silicone on the remaining

Plexiglas stop and screw into place. Wipe away any excess silicone with a damp rag. Continue the steps above for all remaining Plexiglas sheets (Fig. 15). Fill the slight gap between the two large sheets with silicone by running tape along both sides of the seam on each side of the glass, filling the gap, then wiping off any excess. Remove the tape and let dry.

**Installing the door.** Cut all 3 doorstops. If the hinges aren't pre-installed, recess each hinge 10" (measure from the center) from the top and bottom of the door. Place the hinged door in the doorway. It should swing in and the hinges should attach to the 2" x 4" next to the right wall. Use shims under the door to raise it above the floor by about 3/16". Mark the place where the hinges will be screwed in. Remove the door and the frame side of the hinge. Use a chisel to recess the hinge so it's flush with the 2" x 4". Now install the doorknob. When the door is in place and closed, install the remaining doorstops, as above. Be sure the stops rest against the door when closed.

**Exterior finishing.** Apply two coats of Man O' War varnish to all exposed wood for durability.

**Interior painting.** Choose any color combo and paint the interior walls. Stand back and admire your shack!



# FLOOR PLAN

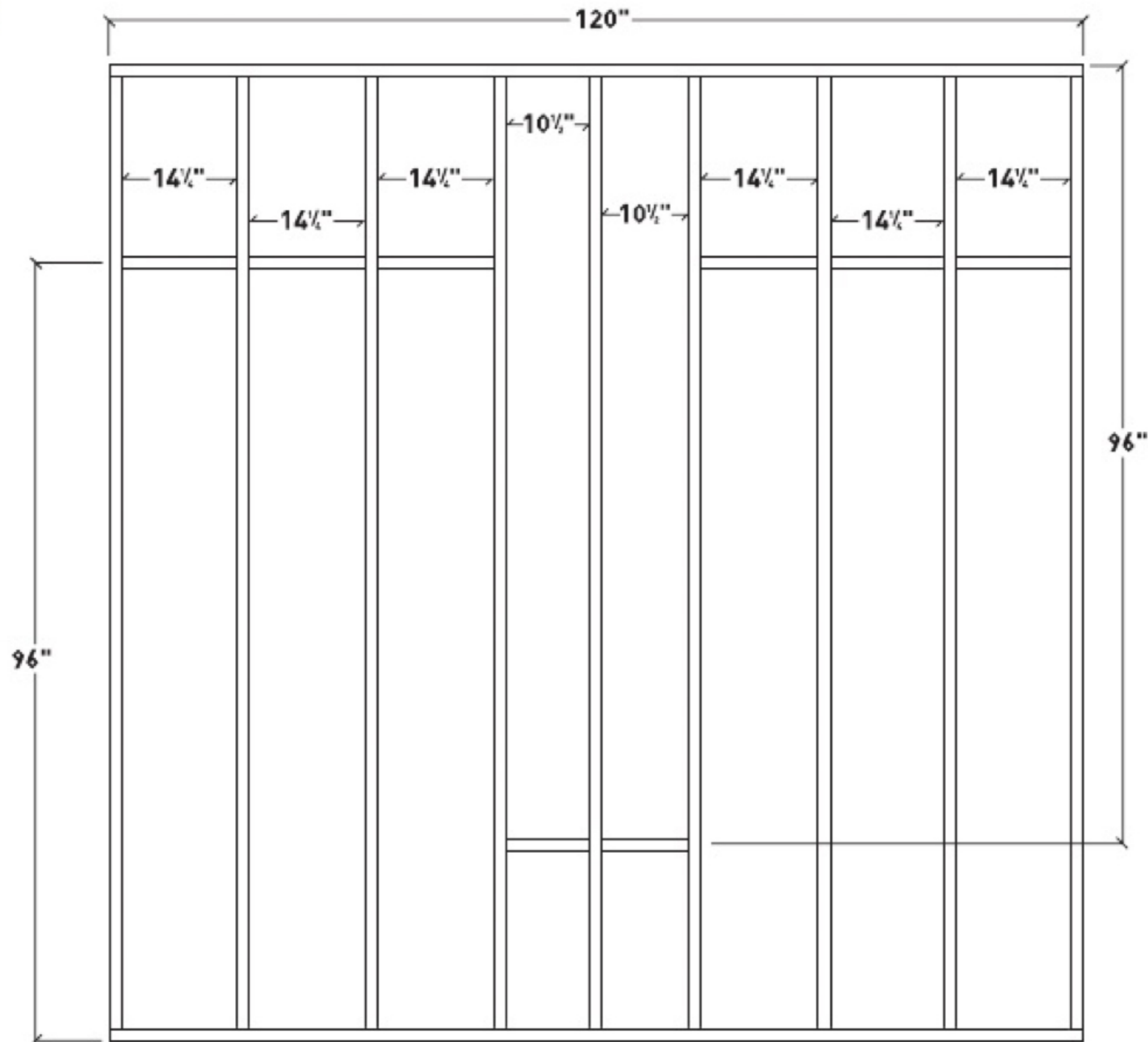

# FRONT ELEVATION

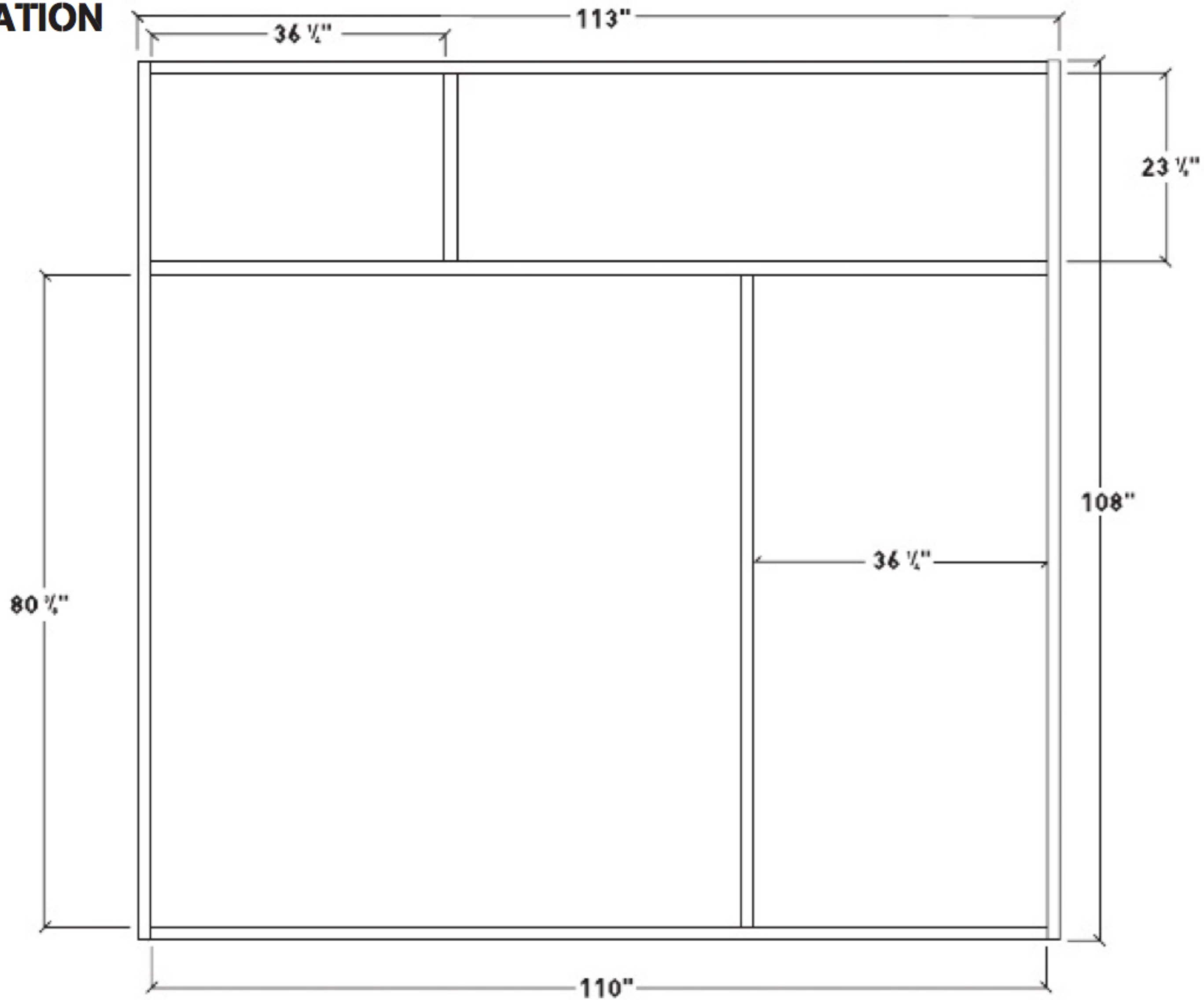

# BACK ELEVATION

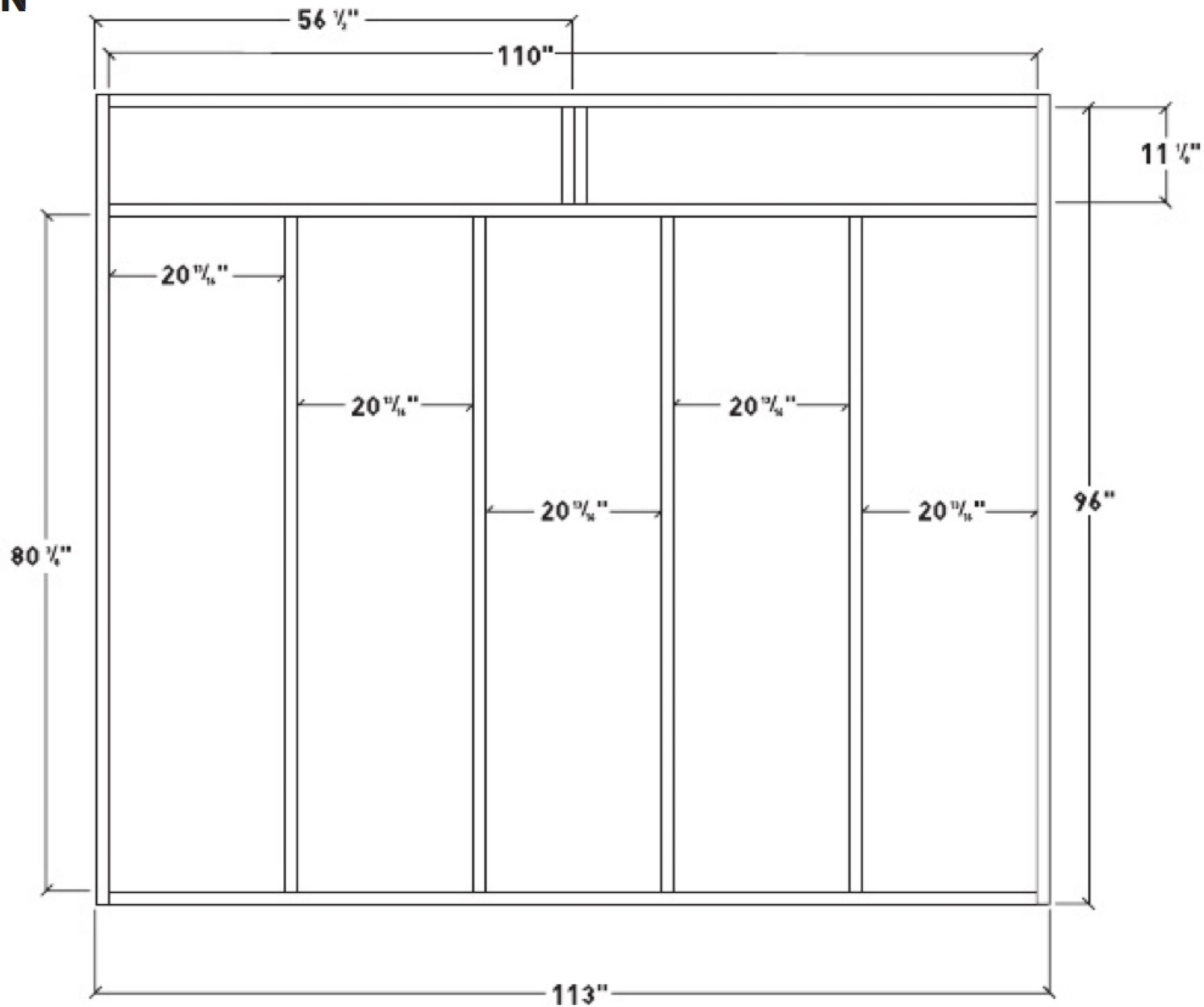

# SIDE ELEVATION

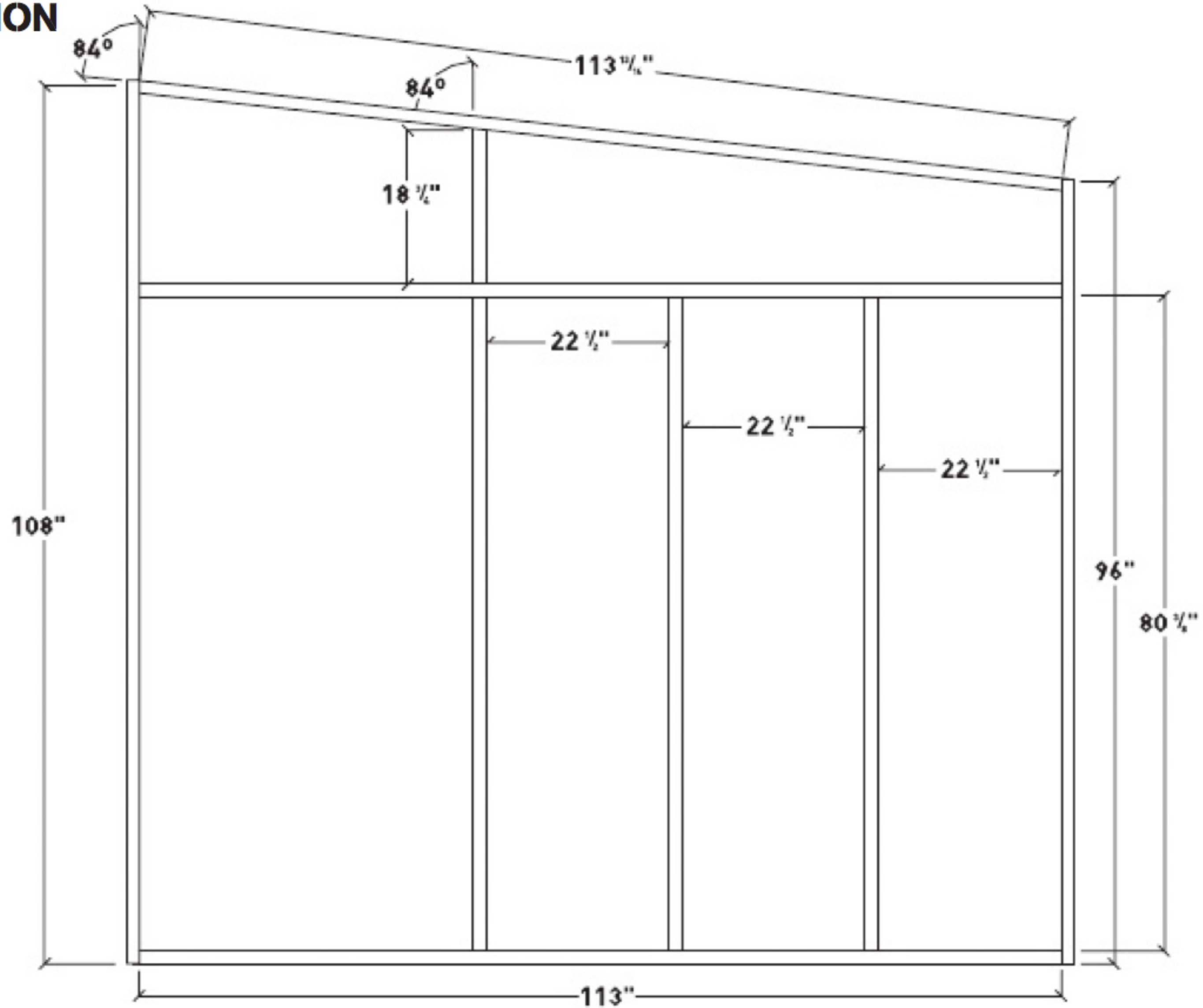



# ROOF PLAN

